

## MIDI® STYLE BOLT-DOWN FUSE RATED 32V

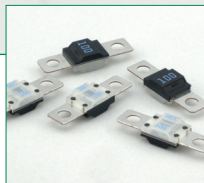

Also available:  
Clear MIDI® version &  
MIDI® one hole version



(transparent nylon composite cover / \*not UL recognized)



### Specifications

Interrupting Rating:	1000A @ 32 VDC
Voltage Rating:	32 VDC
Operating Temperature Range:	-40°C to + 125°C
Housing Material:	Heat Resistant 94-V0 Thermoplastic
Terminal:	Tin plated Copper
Mounting Torque M5:	4.5 Nm +/- 1Nm
Mounting Torque M6:	5.5-6.5 Nm +/- 1Nm
Complies with:	ISO 8820-5 UL 248 Special Purpose Fuses

### Ordering Information













Part Number	Package Size	Mfg Location
<b>M5 Version</b>		
0498xxx.H	100	North America
0498xxx.M*	1000	North America
0498.xxx.M-CN*	1000	Asia
<b>M6 Version</b>		
0498xxx.MXM6*	1000	North America
0498.xxx.MXM6-CN*	1000	Asia
<b>Clear MIDI® Version</b>		
0498xxx.SXT	20	North America
0498xxx.MXT	1000	North America
<b>One Hole Version</b>		
0498xxx.MX1M5*	1000	North America
0498xxx.MX1M5-CN*	1000	Asia

\* Materials manufactured in Asia are produced to the same specifications as materials manufactured in North America, and meets the same test requirements. Multiple production locations are for capacity expansion only.

### Description

This MIDI® style fuse offers a bolt-on space saving fuse for high current wiring protection and provides time delay characteristics with “Diffusion Pill Technology”. The MIDI® was designed and patented by Littelfuse.

### Ratings

Part Number	Current Rating	Housing Material Color	Typ. Voltage Drop Littelfuse max.	Cold Resistance	I²t
0498023._ <sup>2</sup>	23 A		90 mV	3.43 mΩ	1,800 A²s
0498030._ <sup>2</sup>	30 A		65 mV	2.06 mΩ	4,200 A²s
0498040._	40 A		65 mV	1.398 mΩ	10,000 A²s
0498050._	50 A		65 mV	1.025 mΩ	13,000 A²s
0498060._	60 A		68 mV	0.865 mΩ	21,700 A²s
0498070._	70 A		70 mV	0.72 mΩ	24,000 A²s
0498080._	80 A		58 mV	0.541 mΩ	24,600 A²s
0498100._	100 A		60 mV	0.457 mΩ	51,300 A²s
0498125._ <sup>2</sup>	125 A		71 mV	0.394 mΩ	73,200 A²s
0498150._ <sup>1,2</sup>	150 A		77 mV	0.323 mΩ	81,900 A²s
0498175._ <sup>1,2</sup>	175A		77 mV	0.285 mΩ	100,000 A²s
0498200._ <sup>1,2</sup>	200A		77 mV	0.261 mΩ	125,000 A²s

**MIDI® STYLE BOLT-DOWN FUSE RATED 32V**



**Temperature Derating Curve**

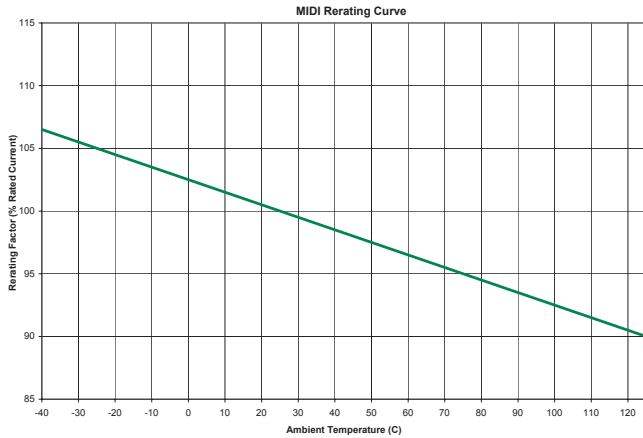

**Time-Current Characteristic Curves**

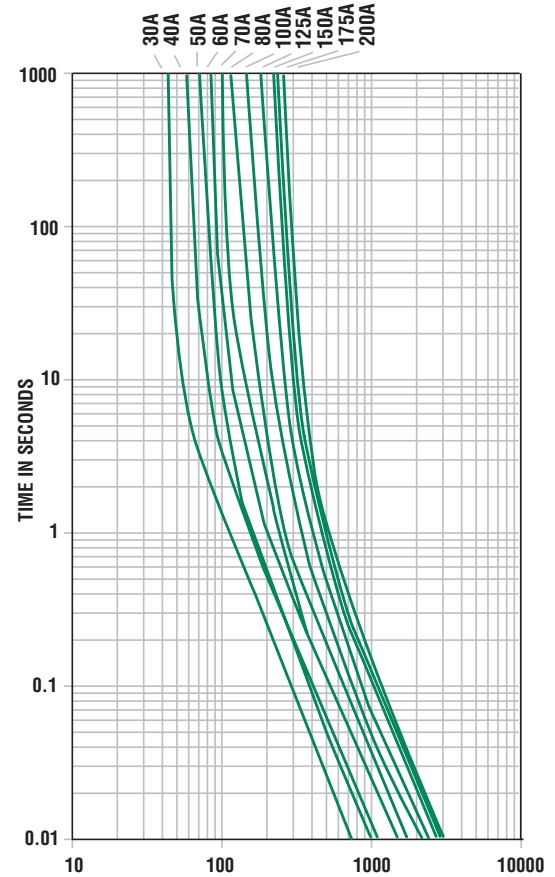

**Dimensions**

Dimensions in mm

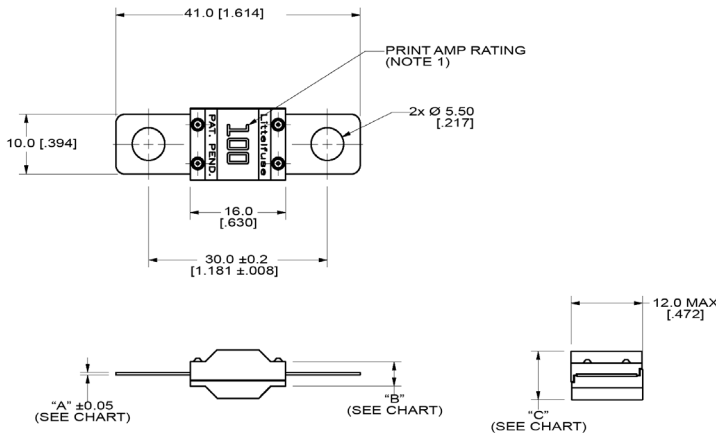

Part Number	"A" mm (inch)	"B" mm (inch)	"C" mm (inch)
0498030_	0.41 (0.016)	4.0 (0.157)	8.0 (0.315)
0498040_	0.41 (0.016)	4.0 (0.157)	8.0 (0.315)
0498050_	0.41 (0.016)	4.0 (0.157)	8.0 (0.315)
0498060_	0.41 (0.016)	4.0 (0.157)	8.0 (0.315)
0498070_	0.41 (0.016)	4.0 (0.157)	8.0 (0.315)
0498080_	0.41 (0.016)	4.0 (0.157)	8.0 (0.315)
0498100_	0.63 (0.025)	4.3 (0.169)	8.3 (0.327)
0498125_	0.63 (0.025)	4.3 (0.169)	8.3 (0.327)
0498150_	0.63 (0.025)	4.3 (0.169)	8.3 (0.327)
0498175_	0.63 (0.025)	4.3 (0.169)	8.3 (0.327)
0498200_	0.63 (0.025)	4.3 (0.169)	8.3 (0.327)

**Time-Current Characteristics**

% of Rating	Opening Time Min / Max (s)	
	30-125A	150-200A
75	- / -	360,000 s / -
100	360,000 s / -	- / -
110	14,400 s / -	- / -
150	90 s / 3,600 s	- / -
200	3 s / 100 s	1 s / 15 s
300	0.3 s / 3 s	- / -
350	- / -	0.3 s / 5 s
500	0.1 s / 1 s	0.1 s / 1 s